

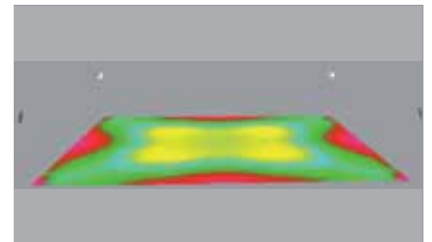

PROGETTO / PROJECT

STADIUM SPORT LIGHTING

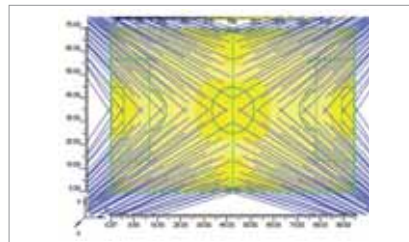

SKI SPORT LIGHTING

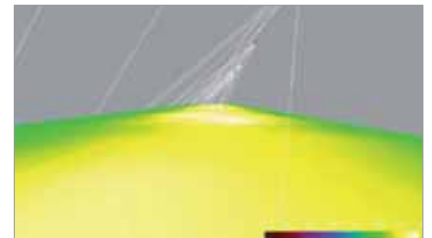
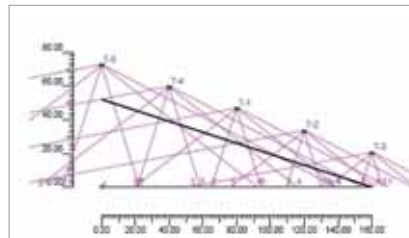
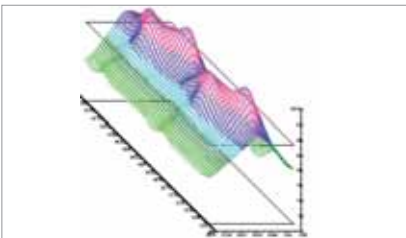



I

Famiglia di proiettori progettati per esaltare le prestazioni illuminotecniche delle lampade da 1000 e 2000W ioduri a doppio attacco con bruciatore ridottissimo. Potenti, compatti, con altissimi rendimenti, con un perfetto controllo del flusso emesso, disponibili nelle versioni con ottica simmetrica e asimmetrica. Ideali per l'illuminazione professionale di grandi superfici, impianti sportivi dove è anche richiesta la possibilità di effettuare le riprese televisive.

IP65/Classe di isolamento I

GB

Series of professional floodlights for overhead lighting via poles or mast for large surface areas including sport centres, car parks, dockyards, interports, airports, road roundabouts. The optics are designed to guarantee high efficiency, high level of light flow control, compliance with current legal regulations relating to light pollution, using sodium and metal halide tubular and short arc lamps from 1000W to 2000W. The following floodlight systems are available with: - symmetric reflector - asymmetric reflector.

IP65 / Insulation class I

EXODON SM

700 x 300 x h720mm

COLOUR	W	A	V	Light	W TOT	PALLETS	dm ³	Kg	Light	CN	CNL
	1000	8,2	230	HLI-T	1075	001	8	168	17,80	E40	● 702111.0101 ● 702111.0140
	1000	9,5	230	HLI-T	1098	001	8	168	17,80	E40	● 702112.0101 ● 702112.0140
	1000	10,3	230	NA-T	1098	001	8	168	17,80	E40	● 702113.0101 ● 702113.0139
	2000	8,8	400	HLI-T	2098	001	8	168	17,80	E40	● 702114.0101 ● 702114.0140
	2000	10,3	400	HLI-T	2138	001	8	168	17,80	E40	● 702115.0101 ● 702115.0140

EXODON AS

700 x 300 x h720mm

COLOUR	W	A	V	Light	W TOT	PALLETS	dm ³	Kg	Light	CN	CNL
	1000	8,2	230	HLI-T	1075	001	8	168	17,80	E40	● 702104.0101 ● 702104.0140
	1000	9,5	230	HLI-T	1098	001	8	168	17,80	E40	● 702105.0101 ● 702105.0140
	1000	10,3	230	NA-T	1098	001	8	168	17,80	E40	● 702106.0101 ● 702106.0139
	2000	8,8	400	HLI-T	2096	001	8	168	17,80	E40	● 702107.0101 ● 702107.0140
	2000	10,3	400	HLI-T	2138	001	8	168	17,80	E40	● 702108.0101 ● 702108.0140

* Per tutte le versioni vengono forniti di serie sia la cassetta di alimentazione sia il relativo accenditore.

* All versions are supplied with control gear and ignitor.

● ARTICOLI CHE, SE NON DISPONIBILI A MAGAZZINO, POSSONO RICHIEDERE FINO A 90 GIORNI PER LA CONSEGNA.
FOR ARTICLES WHICH ARE NOT IN STOCK DELIVERY TIME CAN BE UP TO 90 DAYS.

Corpo e portello posteriore in pressofusione di alluminio, verniciato con polvere termoindurente poliester resistente agli agenti atmosferici e alla corrosione garantita per 1.000 ore in nebbia salina. Il portello posteriore è incernierato al corpo e dotato di una maniglia per agevolare le attività di manutenzione; **Ottica** speculare e martellata in alluminio purissimo 99.85; **Vetro** temperato in piano, spessore di 5 mm; **Portalamпада** ceramico, con molle reggilampada in inox; **Guarnizione** siliconica a cellule chiuse dalle rilevanti prestazioni meccaniche ed elastiche; **Staffa** di installazione con doppia foratura che permette il fissaggio dell'apparecchio nella posizione più idonea; **Goniometro** graduato applicato alla staffa di rotazione per consentire un corretto puntamento; **Viteria** esterna in inox. **Cassetta** laterale in nylon fibra di vetro fornita di serie, ed applicata alla staffa di fissaggio. La versione per lampada da 2000 W HLI-T/D/I non necessita dell'accenditore esterno perché integrato all'interno della lampada. Sulla versione 1000W la piastra di fissaggio per cassetta di alimentazione viene fornita di serie. **Pressacavo**: M20 IP68 antistrappo **In dotazione valvola per il ricircolo dell'aria**. A richiesta sezionatore di sicurezza.

Casing and back door: die cast aluminium, painted with polyester powder paint with high resistance to atmospheric agents and corrosion, guaranteed for 1000 hours in saline mist. Back-door for access and maintenance of the lamp, hinged to the casing and complete with a handle to ease access to fitting. **Glass flat** tempered 5 mm.

Reflectors: pure oxidised aluminium 99,85. **Equipment**: Closed cell silicon **gasket** with three contact points and high mechanical elasticity, M20 IP68 tear proof **cable gland**, switching socket normally supplied. **Graduated angle adjuster** on the stirup to simplify positioning of the floodlight during installation. **Rotating bracket** with double holes to allow optimal positioning during installation. **Nylon box** usually supplied, for electrical connections igniter casing. **Supplied valve for air circulation**. Safety isolating switch on request.

230/380V IP65 EN17 CE 850°

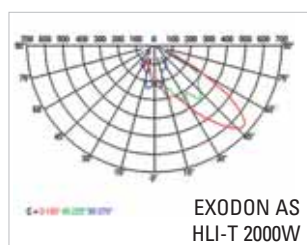
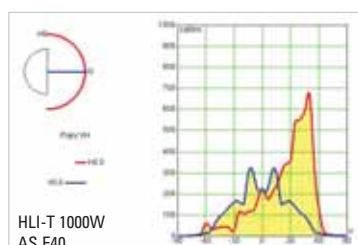
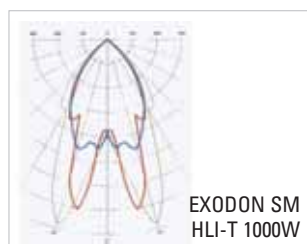
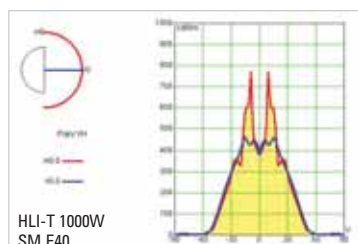
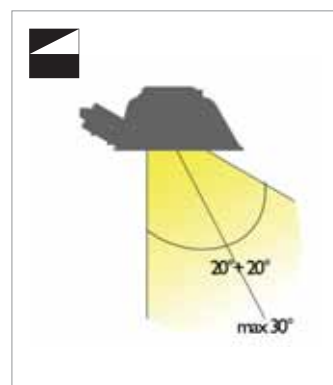
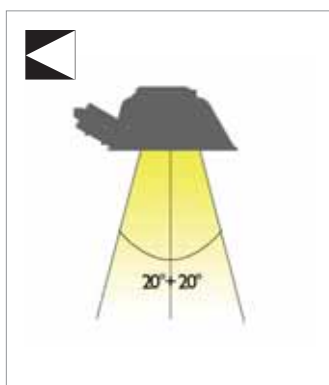
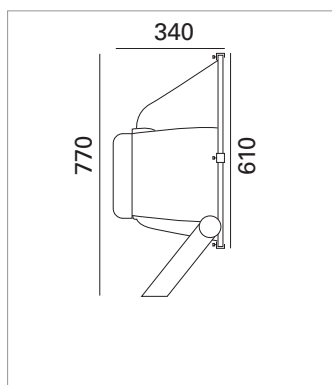
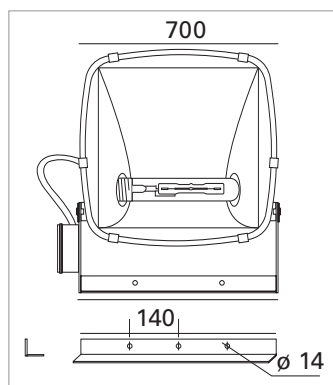

Cambio lampada agevole tramite apertura del coperchio posteriore che resta incernierato al corpo.

Simple lamp replacement by opening the rear hinged cover.



Staffa di rotazione in acciaio zincato a caldo a doppia foratura che facilita l'installazione e permette il fissaggio del proiettore nella posizione più idonea anche grazie all'ausilio del goniometro graduato solidale alla staffa che consente di posizionare l'apparecchio a secondo delle esigenze, ed indirizzare il fascio con la massima precisione. Casseta laterale in nylon fibra vetro (fornita di serie) applicata alla staffa, che permette di effettuare i collegamenti elettrici e di alloggiare l'accenditore.

Rotation rod in hot galvanised steel with double hole to ease installation and allow fixing of the projector in the most suitable position. This, also thanks to the aid of the graduated goniometer joined to the rod, which allows to position the appliance according to requirements and aim the beam with great precision. Lateral case in fibreglass (standard supply) applied to the bracket, which allows to make the electric connections and house the igniter.



Rain Tube incluso.
Rain Tube include.

PROGETTO/PROJECT

BIG OUTDOOR LIGHTING

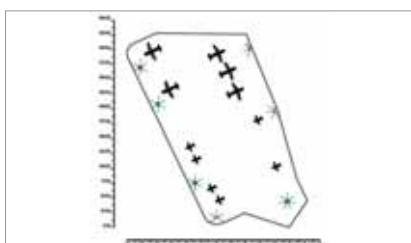
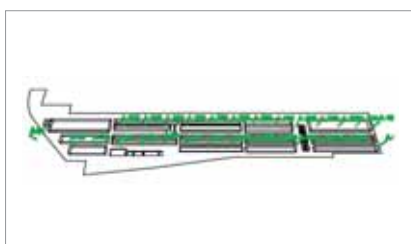

INDOOR SPORT LIGHTING

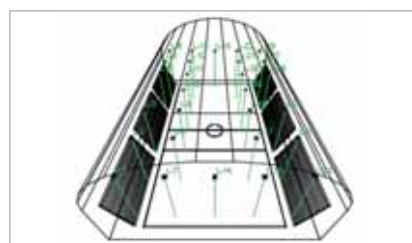
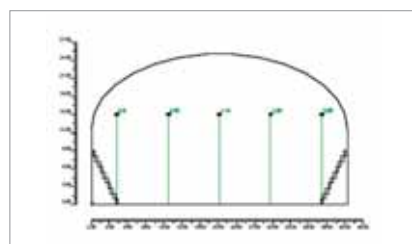

OUTDOOR SPORT LIGHTING

